

M18FFSDC16-0 DRAIN CLEANER 16MM XXX

4933459709 - M18FFSDC16-0 - 4000460936

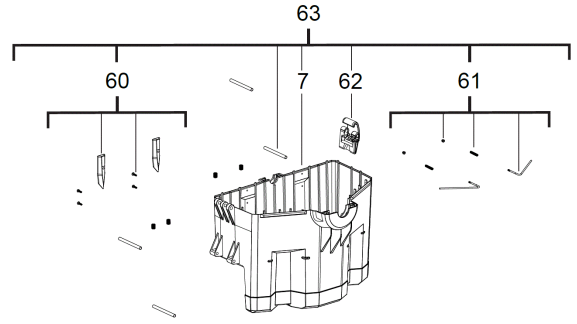

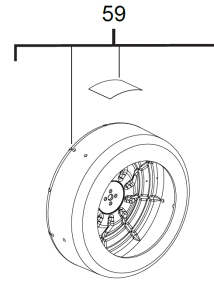

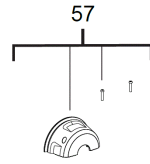
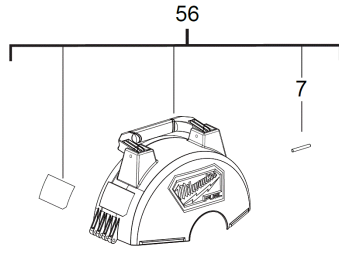
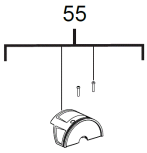
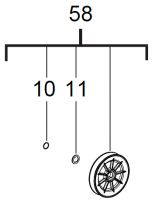
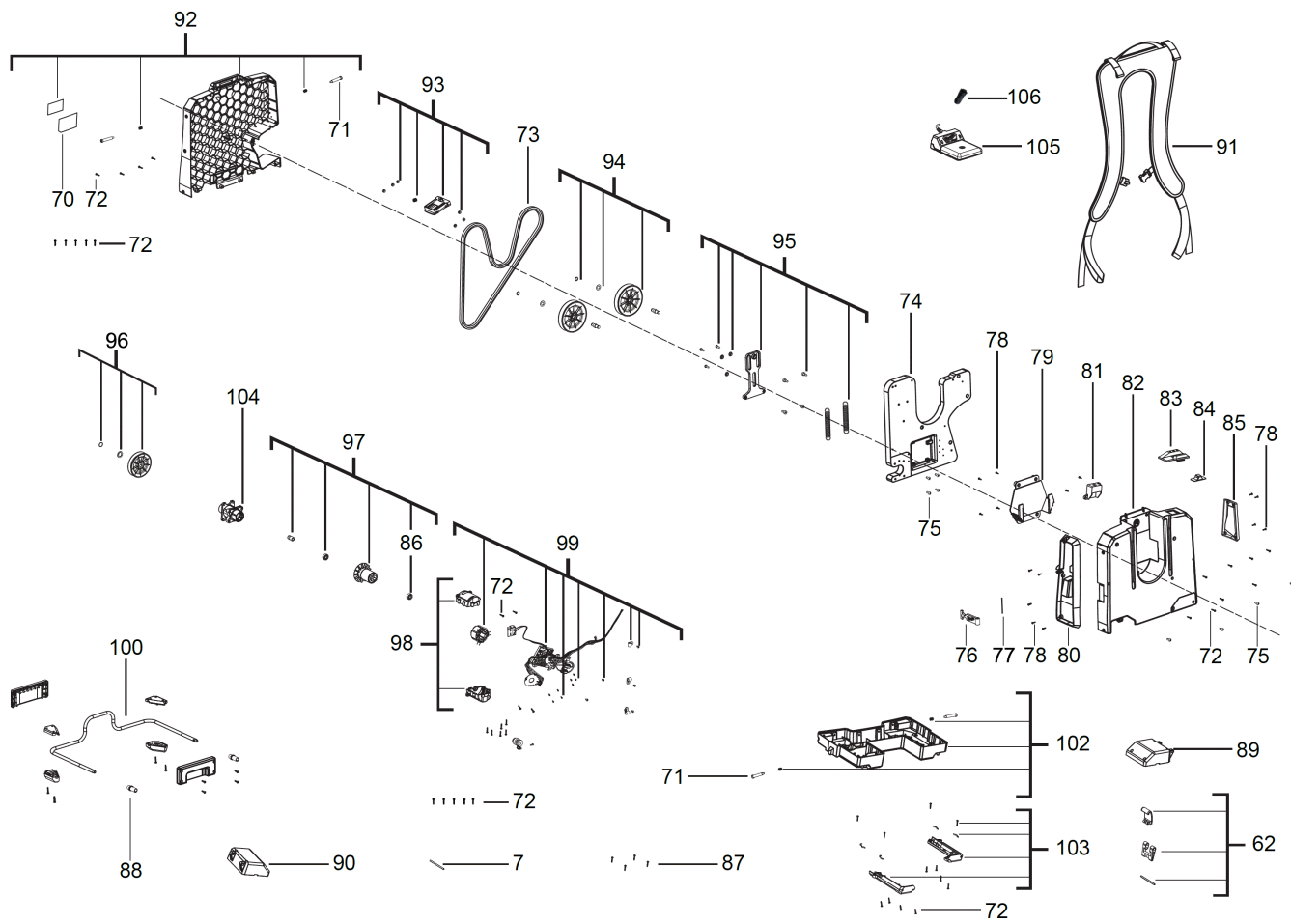

Position	Quantity	Description	Part number	EAN
0007	5	PIN	4931465451	4058546235512
0010	1	RETAINING RING	4931465452	4058546235529
0011	1	WASHER	4931465453	4058546235536
0022	1	CABLE	4931465454	4058546235543
0042	1	10mm x 15m spiral M18FS -1pc	48532773	45242513086
0043	1	13mm x 15m spiral M18FS -1pc	48532774	45242513093
0044	1	16mm x 15m spiral M18FS -1pc	48532775	45242513109
0046	1	Spade Bit M18FS - 1pc	48532788	45242006120
0047	1	Funnel Retriever M18FS -1pc	48532786	45242006106
0048	1	Grease Cutter M18 FS- 1pc	48532789	45242006137
0049	1	Drop Head M18FS-1pc	48532787	45242006113
0050	1	TOOL	4931465455	4058546235550
0055	1	BEARING HOUSING	4931465456	4058546235567
0056	1	HOUSING COVER	4931465457	4058546235574
0057	1	BEARING HOUSING	4931465458	4058546235581
0058	1	FEEDER ROLLER	4931465459	4058546235598
0059	1	MOULDED PART	4931465460	4058546235604
0060	1	GUIDE PIECE	4931465461	4058546235611
0061	2	ROD	4931465462	4058546235628
0062	3	LATCH	4931465463	4058546235635
0063	1	HOUSING BOTTOM	4931465464	4058546235642
0070	1	RATING PLATE	4931465465	4058546235659
0071	4	SCREW	4931465466	4058546235666
0072	43	SCREW	4931454853	4058546020279
0073	1	BELT	4931465467	4058546235673
0074	1	PLATE	4931465468	4058546235680
0075	8	SCREW	4931436390	4002395249589
0076	1	STRAP	4931465469	4058546235697
0077	1	PIN	4931465470	4058546235703
0078	15	SCREW	4931465471	4058546235710
0079	1	BELT GUARD	4931465472	4058546235727
0080	1	RETAINER	4931465473	4058546235734
0081	1	SWITCH MOUNTING	4931465474	4058546235741
0082	1	HOUSING	4931465475	4058546235758
0083	1	SWITCH BOARD	4931465476	4058546235765
0084	1	SLIDING SWITCH	4931465477	4058546235772
0085	1	LABEL	4931465478	4058546235789
0086	1	BALL BEARING	4931436014	4002395875399
0087	8	SCREW	4931465479	4058546235796
0088	2	BUSHING	4931465480	4058546235802
0089	1	HOLDER	4931465481	4058546235819
0090	1	HOLDER	4931465482	4058546235826
0091	1	STRAP	4931465483	4058546235833
0092	1	HOUSING	4931465484	4058546235840
0093	1	TERMINAL STRIP	4931465485	4058546235857
0094	2	FEEDER ROLLER	4931465486	4058546235864
0095	1	TENSIONING DEVICE	4931465487	4058546235871
0096	1	FEEDER ROLLER	4931465488	4058546235888
0097	1	MOTOR ASSEMBLY	4931465489	4058546235895
0098	1	MOTOR HOUSING	4931465490	4058546235901

Position	Quantité	Désignation	Référence	EAN
0099	1	ELECTRONIC	4931465491	4058546235918
0100	1	BASIC SOCKET	4931465492	4058546235925
0102	1	HOUSING BOTTOM	4931465493	4058546235932
0103	1	SLIDER	4931465494	4058546235949
0104	1	GEAR CASE	4931465495	4058546235956
0105	1	FOOT PEDAL	4931465496	4058546235963
0106	1	PLUG	4931466591	4058546278083