

# M12FDGS-422B F. STR. DIE GRINDER-KIT IN2

4933471436 - M12FDGS-422B - 4000474800

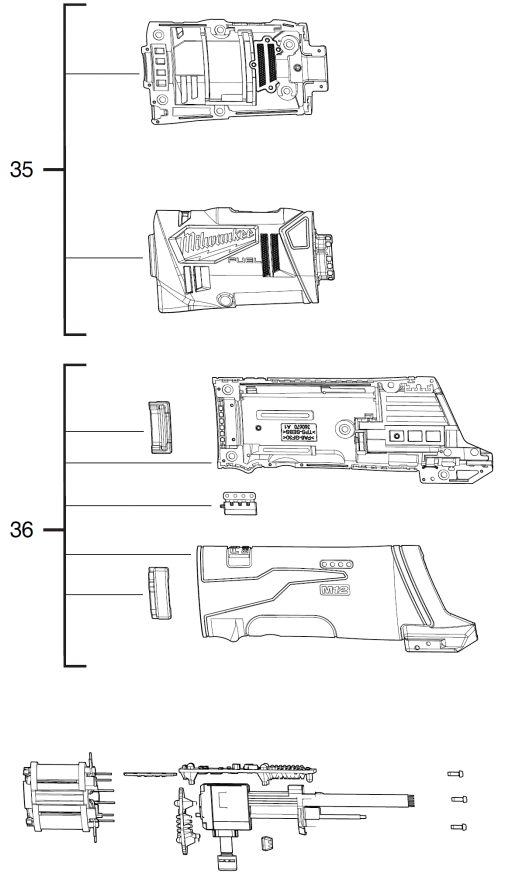

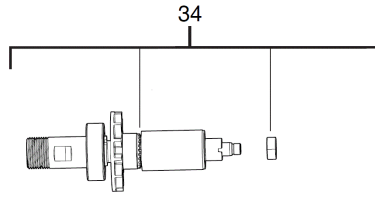
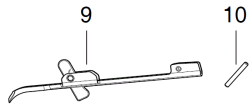
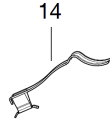
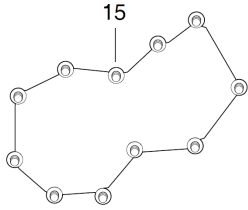
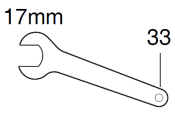
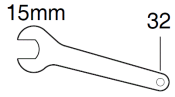
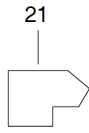
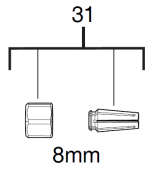
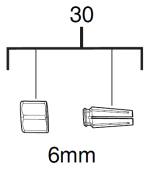

<b>Position</b>	<b>Quantity</b>	<b>Description</b>	<b>Part number</b>	<b>EAN</b>
0009	1	LEVER	4931472886	4058546331887
0010	1	PIN	4931435254	4002395897414
0014	1	SPRING ELEMENT	633680001	4002395849413
0015	11	SCREW	660230016	4002395849840
0021	1	RATING PLATE	4931472887	4058546331894
0030	1	COLLET	4931472587	4058546328894
0031	1	COLLET	4931472588	4058546328900
0032	1	WRENCH	4931461257	4058546034290
0033	1	WRENCH	4931461258	4058546034306
0034	1	ROTOR	4931472590	4058546328924
0035	1	HOUSING MOTOR SIDE	4931472888	4058546331900
0036	1	HOUSING	4931472889	4058546331917